



OWNERS CARE MANUAL (For Flat Washer Faucet Models)

THE UTOPIA CONCEPT

Your new Utopia faucet has been designed for both beauty and durability and will provide years of dependable service. Its one piece shield has undergone extensive treatment to help maintain its lustrous beauty year after year. And, its underbody parts are made of a corrosive free material that prevents water mineral build-up.

Your Utopia faucet features a patented, self-aligning plunger action stem with a non-rotating tip. This means no washer wear, the primary cause of drips and leaks. Instead, Utopia's gentle plunger action raises and lowers the stem to control water flow.

CARE OF EXTERIOR FINISHES

Clean faucets only with a damp soft cloth or sponge.

Do not use abrasive cleaners or materials as they will damage finish.

VACUUM BREAKERS

For your protection, some faucets are equipped with a vacuum breaker (back flow preventer) to prevent contamination of your potable water supply. The water in the hand held shower hose will drain through this vacuum breaker when the faucet is turned off. This is not a leak. This drain is inherent in the design of the vacuum breaker, and is evidence that it is functioning properly.

FIVE-YEAR LIMITED WARRANTY

BPC Manufacturing warrants its Utopia® faucets to be free from manufacturing defects for a period of five years from the date of purchase. Finishes other than chrome plated are warranted for one year. This limited warranty extends to all owners during the warranty period.

Warranty is limited to the repair or replacement of the faucet or faucet part which proves to be defec-

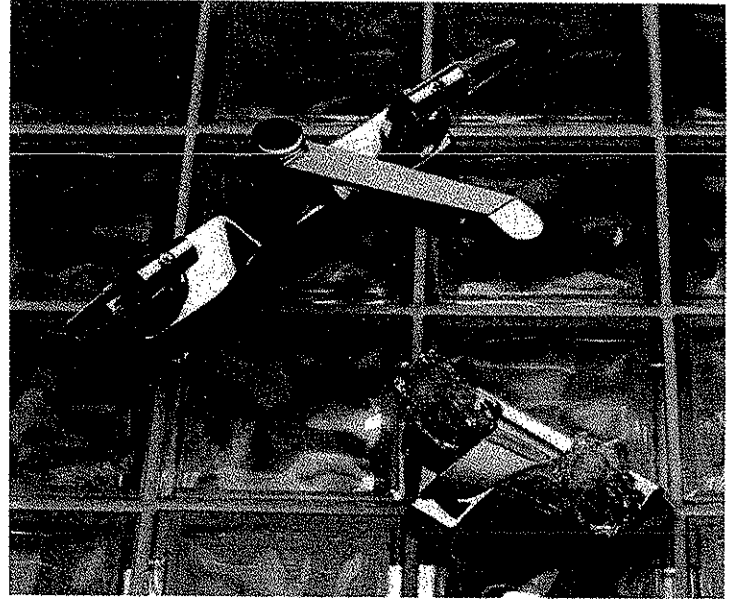

tive under normal usage and service and excludes any removal or installation costs. This warranty shall not apply to goods which have been subject to accident, negligence or misuse, intentional damage, alterations or incorrect installation.

THIS LIMITED WARRANTY SPECIFICALLY EXCLUDES INCIDENTAL AND CONSEQUENTIAL DAMAGE OF EVERY TYPE AND DESCRIPTION RESULTING FROM ANY CLAIMED DEFECT IN MATERIAL.

This limited warranty is specifically in lieu of all other expressed warranties on the part of BPC Manufacturing, and no representative of BPC Manufacturing has the authority to make any other warranties concerning Utopia faucets on behalf of the company except to refer purchasers to this warranty. Further, any implied warranties arising by operation of law are specifically limited to the scope and/or duration of this written warranty.

Some states do not allow exclusions or limitations of incidental or consequential damages or allow limitations on how long an implied warranty lasts; thus the above stated exclusions or limitations may not apply to you. Further, this warranty gives you specific legal rights, and you may also have other legal rights which vary from state to state.

MAINTAINING YOL

STANDARD DUAL CONTROL FAUCETS

Utopia's patented design eliminates washer wear -- the common cause of leaking. Should your faucet have or develop a leak, it is probably caused by debris which has become lodged in your water line causing improper seating of the stem tip.

To eliminate a faucet leak, follow these steps carefully:

1. Turn faucet on and off several times to flush out any debris which may be in the line preventing the stem tip from seating properly. In many cases this will completely eliminate a leak or drip. If problem persists, continue with the following steps.
2. Unsnap the "Hot" or "Cold" button (A) on the handle.
3. Remove the screw (B), with a phillips head screwdriver, turning the screw counterclockwise.
4. Lift off the handle (C).
5. Turn off the water supply.
6. Remove the faucet stop (E) by placing a flat screwdriver in slot (F) on the side of the stop and pry it up.
7. Loosen the stem and bonnet assembly (H) with a crescent wrench by turning it counterclockwise and remove it by simply lifting it off with your fingers.
8. If there is foreign debris in the faucet, remove it by flushing or picking it out.
9. Check the flat washer for possible damage. If the flat washer is damaged, a new one can be purchased at a local hardware store.
10. To re-assemble, turn the stem (G) counterclockwise to a full open position.
11. Screw in the stem and bonnet assembly (H) fingertight.
12. Snug up the stem and bonnet assembly assembly (H) with a crescent wrench. You will notice four slots (I) on the top of the bonnet (J). Turn the stem and bonnet assembly (H) until these slots show white rather than chrome. Do not overtighten.

13. Place the faucet stop (E) in the slots. This should snap into place. If it does not, you do not have the slots properly aligned as instructed in step 13. Re-align.

14. Replace handle by pushing it down over the stem (G).

15. Replace and tighten the screw (B) (clockwise) and replace the "Hot" and "Cold" button (A). **Be sure screw is tightened completely so handle is completely down.**

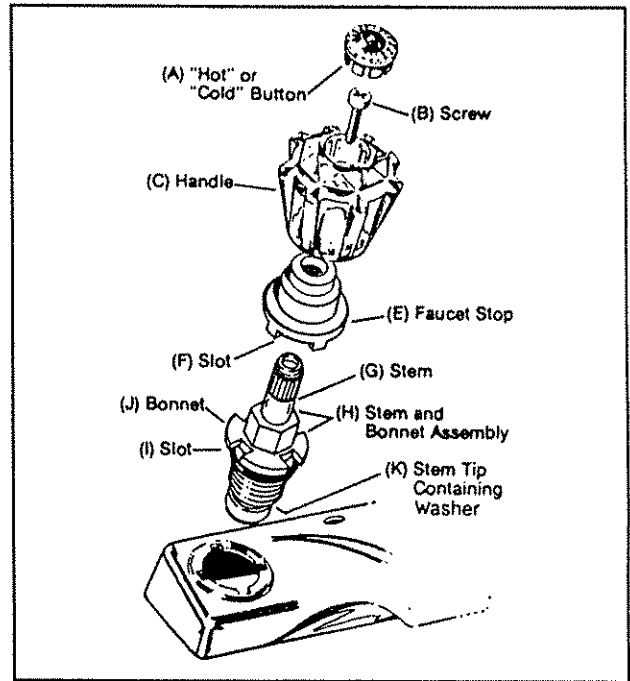

LEVER HANDLE DUAL CONTROL MODELS

Utopia's patented design eliminates washer wear — the common cause of leaking. Should your faucet have or develop a leak, it is probably caused by debris which has become lodged in your water line causing improper seating of the stem tip.

1. Turn faucet on and off several times to flush out any debris which may be in the line preventing the stem tip from seating properly. In many cases, this will completely eliminate a leak or a drip. If problems persist, continue with the following steps.
2. Remove the screw (B) with a phillips head screwdriver from the COLD SIDE of the faucet (RIGHT SIDE) by turning the screw (B) COUNTERCLOCKWISE. For the HOT SIDE (LEFT SIDE) turn screw (B) COUNTERCLOCKWISE also.
3. Lift off the faucet handles (C).
4. TURN OFF THE WATER SUPPLY.
5. Remove the faucet stop (E) by placing a flat screwdriver in slot (F) on the side of the stop and pry it up.

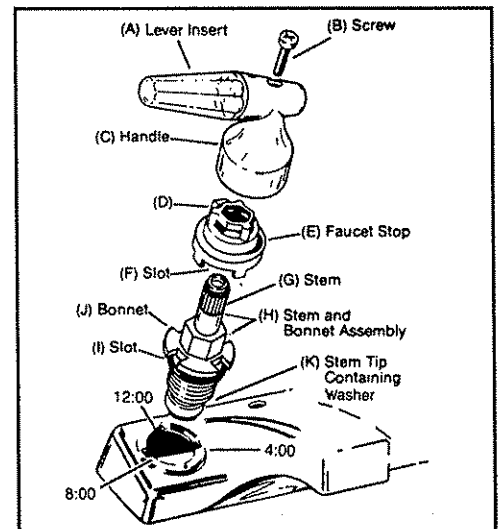

3 UTOPIA FAUCET

6. Loosen the stem and bonnet assembly (H) with a crescent wrench by turning it COUNTER-CLOCKWISE and remove it by simply lifting off with your fingers. For HOT SIDE repeat same as cold side.

7. If there is foreign debris in the faucet, remove it by flushing or picking it out.

8. Check the flat washer for possible damage. If the flat washer is damaged, a new one can be purchased at a local hardware store.

9. To re-assemble COLD SIDE turn the stem (G) CLOCKWISE to a fully open position. For the HOT SIDE turn the stem (G) COUNTERCLOCKWISE to a fully open position.

10. Screw in the stem and bonnet assembly (H) finger tight.

11. Snug up the stem and bonnet assembly (H) with a crescent wrench. You will notice four slots (I) on the bonnet (J). Turn the stem and bonnet assembly (H) until these slots show white rather than chrome. Do not overtighten.

12. Turn the COLD SIDE stem (G) COUNTERCLOCKWISE to a fully closed position (see Figure 1). Turn HOT SIDE stem (G) CLOCKWISE to a fully closed position (see Figure 1).

13. Place the faucet stop (E) in the slots (I) with the raised part (D) at the 12 o'clock position. This should snap into place. If it does not, you do not have the slots properly aligned as instructed in step 11. Re-align.

14. For COLD SIDE: Position the handle (C) pointing to the 4 o'clock position over the faucet stop (E) (see Figure 2) and replace the handle by pushing it down over the stem (G).

For HOT SIDE: Position the handle (C) pointing to the 8 o'clock position over the faucet stop (E) (see Figure 2) and replace the handle by pushing it down over the stem (G).

15. Replace and tighten the screw (B) CLOCKWISE for both COLD SIDE and HOT SIDE. Be sure the screw is tightened completely so the handle is completely down.

16. **TURN ON THE WATER SUPPLY.**

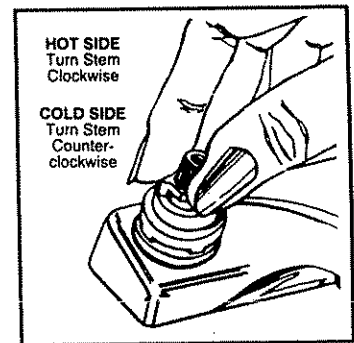

Figure 1

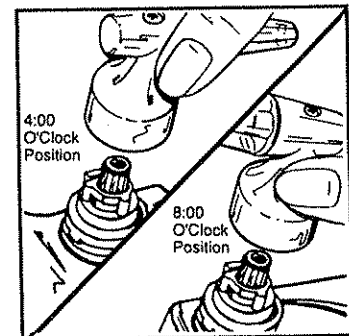
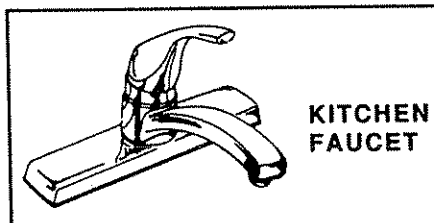
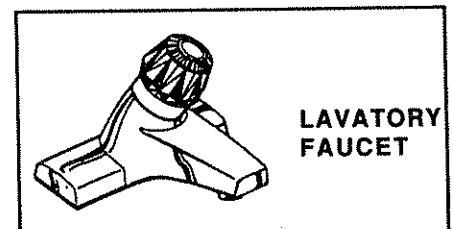

Figure 2

SINGLE CONTROL NON-METALLIC FAUCETS



KITCHEN FAUCET



LAVATORY FAUCET

DISASSEMBLY

1. TURN OFF WATER TO FAUCET
2. Loosen set screw in rear of lever handle. Remove handle (A).
3. Remove handle adapter (B) for lever handle. (Use phillips screwdriver).
4. Snap bonnet cover (C) off bonnet nut.
5. Unscrew and remove bonnet nut (D).
6. Remove control cartridge (E) by pulling control stem with pliers. Check inside of core for seals and for sediment from water. Clean if necessary.

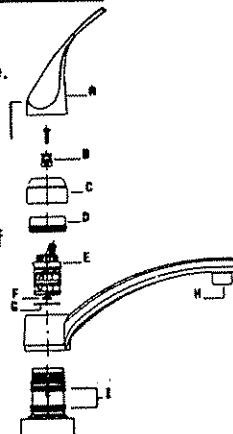

REASSEMBLY

7. Make sure square cut seals (F) are in place on the bottom of the cartridge. Make sure lower "O" ring (G) is in bottom of core for kitchen models with spray. Place cartridge into core and push all the way down, making sure that tab on core goes into slot at rear of core.
8. Replace bonnet nut and tighten firmly by hand.
9. To replace bonnet cover, align lock tabs with slots in bonnet nut and press firmly into place. If bonnet cover does not snap into place, back off nut only enough to allow engagement of cover teeth into control teeth.
10. Replace handle adapter and lever handle. Turn on water supply. Check for leaks and drips.

DISASSEMBLY

1. TURN OFF WATER SUPPLY TO FAUCET.
2. Remove handle (A). Carefully remove plug button and remove screw in crystal handle.
3. For models with lever handle, loosen set screw in rear of handle and remove. Remove handle adapter (use phillips screwdriver).
4. Snap bonnet cover (B) off bonnet nut.
5. Unscrew and remove bonnet nut (C).
6. Remove control cartridge (D) by pulling control stem with pliers. Check inside of core for seals and for sediment from water. Clean if necessary.

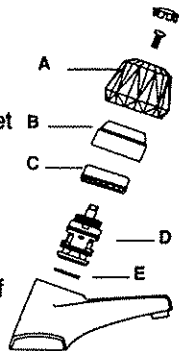

REASSEMBLY

7. Make sure square seals (E) are in place on bottom of cartridge. Place cartridge into core and push all the way down, making sure that tab on control goes into slot at rear of core.
8. Replace bonnet nut and tighten firmly by hand.
9. To replace bonnet cover, align lock tabs with slots in bonnet nut and press firmly into place. If bonnet cover does not snap into place, back off nut only enough to allow engagement of cover teeth in control teeth.
10. Replace handle (and handle adapter for lever handle). Turn on water supply. Check for leaks and drips.

MAINTENANCE (CONT'D)

Instructions for replacing L10228B Diverter Spool and Spring Assembly

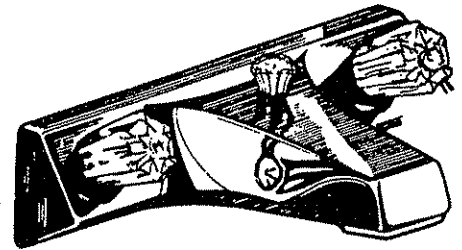
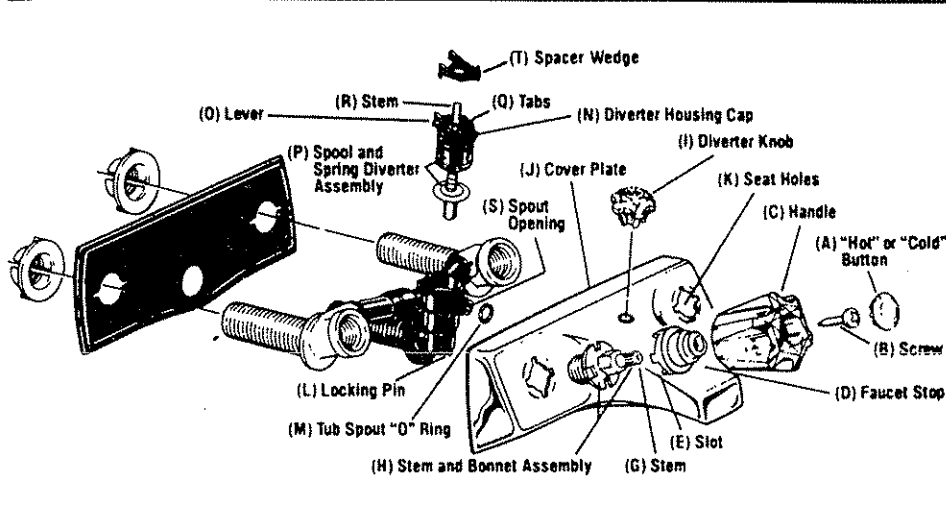

1. **TURN OFF THE WATER SUPPLY.**
2. Unsnap the "Hot" and "Cold" buttons (A) on the handle.
3. Remove the screw (B) with a phillips head screwdriver, turning the screw counterclockwise.
4. Lift off the handle (C).
5. Remove the faucet stop (D) by placing a flat screwdriver in slot (E) on the side of the stop and prying it up.
6. Loosen the stem and bonnet assembly (H) with a crescent wrench by turning it counterclockwise and remove it by simply lifting off with your fingers.
7. Unscrew and remove diverter knob (I).
8. Remove cover plate (J) by placing hands on top above seat holes (K) and press firmly down. Cover plate will snap out of locking pin (L) on bottom. Lift cover plate (see illustration #1).
9. Remove and discard the tub spout "O" ring (M). This may have remained inside the cover plate. Replace with new one from kit on spout opening (S).
10. Loosen spacer wedge (T) by slipping a screwdriver between it and diverter housing cap. Lift spacer wedge off.
11. Place a pair of pliers across the top of diverter housing cap (N) so that it engages the key or lever (O) which extends above the cap. Turn cap to the left until tabs open (see illustration #2).
12. Pry cap up with screwdriver and remove entire spool and spring diverter assembly (P).
13. Using new spool and spring diverter assembly (P) in kit, slip unit into center body with lever (O) towards the wall. (See illustration #3).
14. Using pliers as described in step #11 above, turn to the right while pushing gently down until tabs (Q) are locked in place.
15. Replace spacer wedge (T) with tall levers pointing towards wall.
16. Tip cover plate (J) upward pushing stem (R) through opening on top. Making sure that the "O" ring (M) is securely in place on center body spout opening (S), gently replace cover plate so that hot and cold openings line up. Press shield downward until you hear locking pin (L) snap into place (see illustration #4).
17. With stem and bonnet assembly (H) in hand, turn the stem (G) counterclockwise to a full open position.
18. Screw in the stem and bonnet assembly (H) finger tight.
19. Snug up the stem and bonnet assembly (H) with a crescent wrench. You will notice four slots on the top of the bonnet. Turn the stem and bonnet assembly (H) until these slots show white rather than chrome. **Do not overtighten.**
20. Replace the faucet stop (D) in the slots. Stops should snap into place (see illustration #5). If it does not, you do not have the slots properly aligned as instructed in Step 19. Realign.
21. Replace handle down over the stem (G).
22. Replace and tighten the screw (B) (clockwise) and replace the "hot" and "cold" buttons (A). Be sure screw is tightened completely.
23. Replace diverter knob (I).
24. Turn on water supply. Faucet is now ready to use.

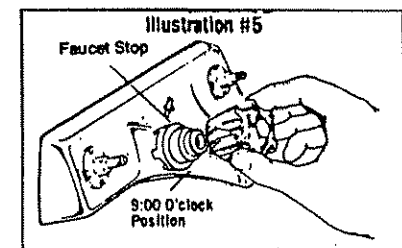
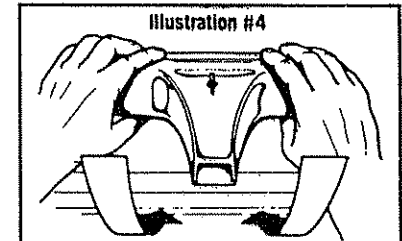
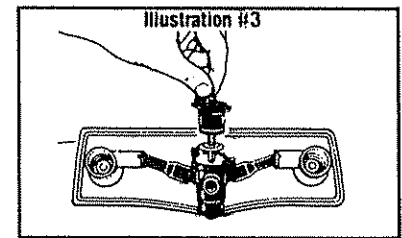
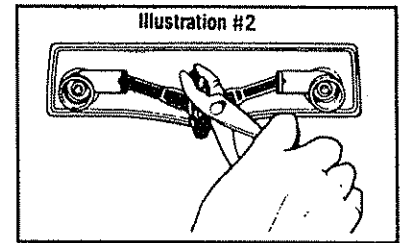
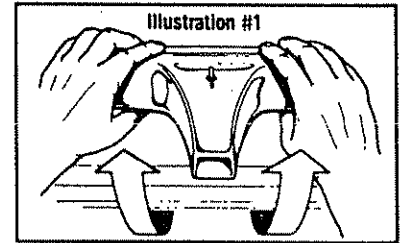

NOTE: Periodic lubrication of the diverter stem with petroleum jelly will prevent sticking. Lift the diverter knob and apply a small amount to the outside of the diverter shaft. Lift up and push down the knob 8 to 10 times to lubricate the shaft and "O" ring inside the diverter spool. This should be done any time the diverter sticks in the shower position.

For additional SERVICE INFORMATION, write or call toll free:

